

## 概述

SP78SXX 系列主要用于各种电视机、收录机、电子仪器、电子设备、电子控制电路的稳压电源电路。它包括 SP78S05、SP78S08、SP7809 等常规品种。

## 特点

- ◆ 三端稳压集成，外围元件少，适用性强；
- ◆ 功放输出过流、过热保护；
- ◆ 输出电流大： $I_{omax}=200mA$ ；
- ◆ 封装形式：SOT-89、TO-92

## 管脚说明

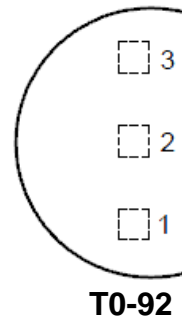
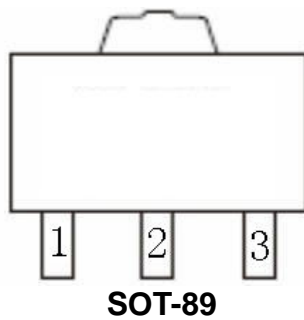

引脚	功能	符号
1	输出	OUT
2	地	GND
3	输入	IN

## 性能参数

极限值（绝对最大额定值，若无其它规定， $T_{amb}=25^{\circ}C$ ）

参数名称	符号	数值		单位
		最小	最大	
输入电压	$V_I$		35	V
工作环境温度	$T_{amb}$	-20	85	$^{\circ}C$
贮存温度	$T_{stg}$	-55	150	$^{\circ}C$

电特性(若无其它规定, Tamb=25°C)

## 78S05

参数名称	参数符号	测试条件	最小	典型	最大	单位
输出电压	Vo	Vi=10V, Io=40mA	4.8		5.2	V
		Io=1~200mA, Vi=7.5~13V	4.75		5.25	V
		Vi=7-20V, Io=1~40mA	4.75		5.25	V
		Vi=10V, Io=1mA-70mA	4.75		5.25	V
电压调整率	ΔVo	Vi=7~20V, Io=40mA			150	mV
纹波抑制比	RR	f=120Hz	40.0			dB
电流调整率	ΔVo	Vi=10V, Io=5~200mA			150	mV
静态电流	Iq	Vi=10V, Io=40mA			6	mA
静态电流变化率	ΔIq	Vi=8V~20V, IO=40mA			1.5	mA
		Vi=10V, IO=5mA~100mA			0.5	mA
最大输出电流	Io				200	mA

## 78S08

参数名称	参数符号	测试条件	最小	典型	最大	单位
输出电压	Vo	Vi=10V, Io=40mA	7.7		8.3	V
		Io=1~200mA, Vi=7.5~13V	7.6		8.4	V
		Vi=7-20V, Io=1~40mA	7.6		8.4	V
		Vi=10V, Io=1mA-70mA	7.6		8.4	V
电压调整率	ΔVo	Vi=7~20V, Io=40mA			150	mV
纹波抑制比	RR	f=120Hz	40.0			dB
电流调整率	ΔVo	Vi=10V, Io=5~200mA			150	mV
静态电流	Iq	Vi=10V, Io=40mA			6	mA
静态电流变化率	ΔIq	Vi=8V~20V, IO=40mA			1.5	mA
		Vi=10V, IO=5mA~100mA			0.5	mA
最大输出电流	Io				200	mA

## 78S09

参数名称	参数符号	测试条件	最小	典型	最大	单位
输出电压	Vo	Vi=10V, Io=40mA	8.65		9.35	V
		Io=1~200mA, Vi=7.5~13V	8.55		9.45	V
		Vi=7-20V, Io=1~40mA	8.55		9.45	V
		Vi=10V, Io=1mA-70mA	8.55		9.45	V
电压调整率	ΔVo	Vi=7~20V, Io=40mA			150	mV
纹波抑制比	RR	f=120Hz	40.0			dB
电流调整率	ΔVo	Vi=10V, Io=5~200mA			150	mV
静态电流	Iq	Vi=10V, Io=40mA			6	mA
静态电流变化率	ΔIq	Vi=8V~20V, IO=40mA			1.5	mA
		Vi=10V, IO=5mA~100mA			0.5	mA
最大输出电流	Io				200	mA

## 性能曲线

Maximum Average Power Dissipation (Z Package)

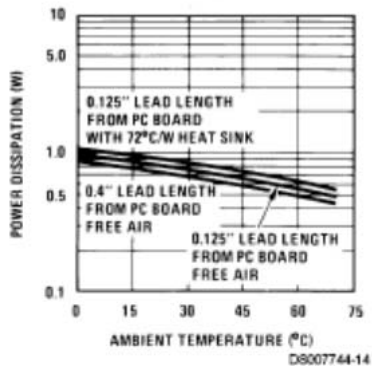

Peak Output Current

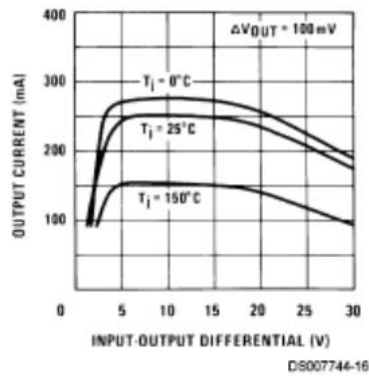

Dropout Voltage

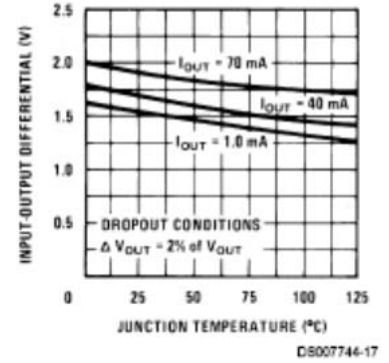

Ripple Rejection

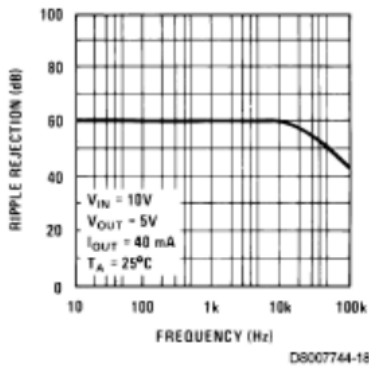

Output Impedance

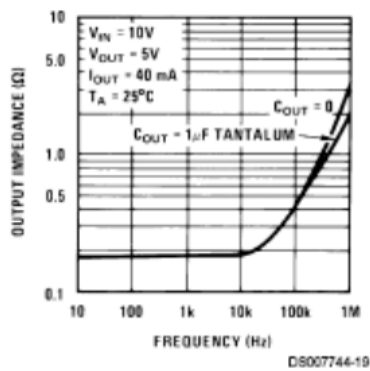

Quiescent Current

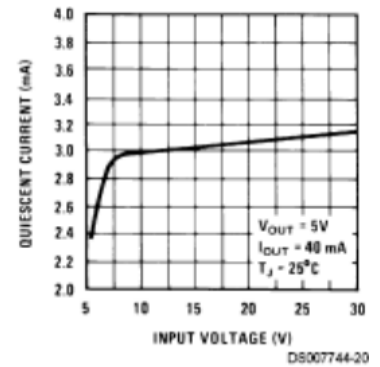

Quiescent Current

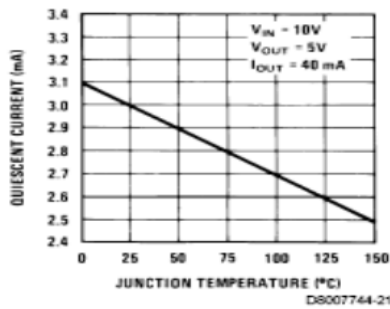

## 典型应用图

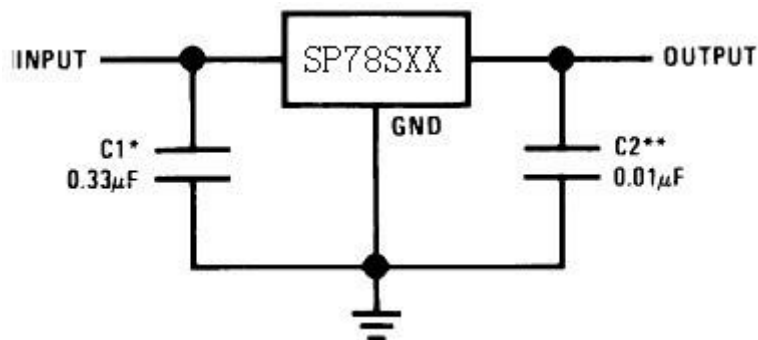

**Copyright © 2008 by HOTCHIP TECHNOLOGY CO., LTD.**

The information appearing in this Data Sheet is believed to be accurate at the time of publication. However, HOTCHIP assumes no responsibility arising from the use of the specifications described. The applications mentioned herein are used solely for the purpose of illustration and HOTCHIP makes no warranty or representation that such applications will be suitable without further modification, nor recommends the use of its products for application that may present a risk to human life due to malfunction or otherwise. HOTCHIP's products are not authorized for use as critical components in life support devices or systems. HOTCHIP reserves the right to alter its products without prior notification. For the most up-to-date information, please visit our web site at <http://www.hotchip.net.cn>.