



FEATURES

- Glass Passivated Die Construction
- Fast Recovery Time For High Efficiency
- Low Forward Voltage Drop and High Current Capability
- Surge Overload Rating to 30A Peak
- Ideally Suited for Automated Assembly
- Plastic Material: UL Flammability Classification Rating 94V-0

Mechanical Data

- Case: Molded Plastic
- Terminals: Solder Plated Terminal - Solderable per MIL-STD-202, Method 208
- Polarity: Cathode Band or Cathode Notch
- SMA Weight: 0.064 grams (approx.)
- SMB Weight: 0.093 grams (approx.)
- Mounting Position: Any
- Marking: Type Number

DO-214AC(SMA)

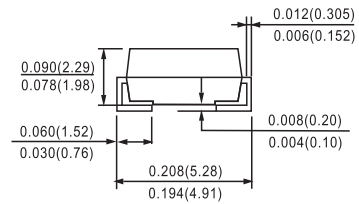
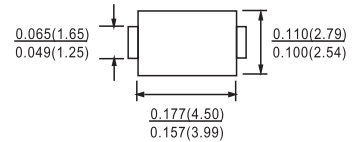

Dimensions in inches and (millimeters)

MAXIMUM RATINGS AND ELECTRICAL CHARACTERISTICS

Ratings at 25°C ambient temperature unless otherwise specified
 Single phase, half wave, 60Hz, resistive or inductive load
 For capacitive load, derate current by 20%

	SYMBOL	RS1A	RS1B	RS1D	RS1G	RS1J	RS1K	RS1M	UNITS
Maximum Repetitive Peak Reverse Voltage	V _{RRM}	50	100	200	400	600	800	1000	Volts
Maximum RMS Voltage	V _{RMS}	35	70	140	280	420	560	700	Volts
Maximum DC Blocking Voltage	V _{DC}	50	100	200	400	600	800	1000	Volts
Maximum Average Forward Rectified Current .0375" (9.5mm)Lead Length at T _A = 55°C	I _(AV)	1.0							Amps
Peak Forward Surge Current 8.3ms Single Half Sine-Wave Superimposed on Rated Load (JEDEC Method)	I _{FSM}	30							Amps
Maximum Instantaneous at 1.0A DC	V _F	1.3							Volts
Maximum DC Reverse Current @T _A =25°C at Rated DC Blocking Voltage @T _A =100°C	I _R	5.0 100							μA
Maximum Reverse Recovery Time	T _{RR}	150			250		500		nS
Typical Junction Capacitance	C _J	15							pF
Operating Temperature Range	T _J	+175							°C
Storage Temperature Range	T _{STG}	-65 to +175							°C

NOTES :

1. Measured at 1 MHz and applied reverse Voltag of 4.0VDC
2. Thermal Resistance Junction to case



RATINGS AND CHARACTERISTIC CURVES

RS1A THRU RS1M

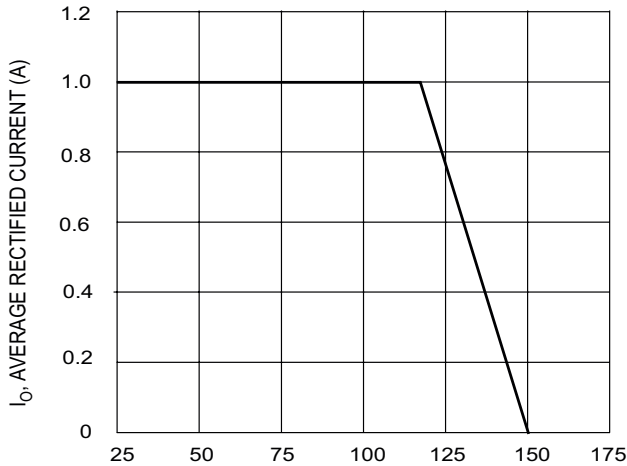

Fig. 1 Forward Current Derating Curve

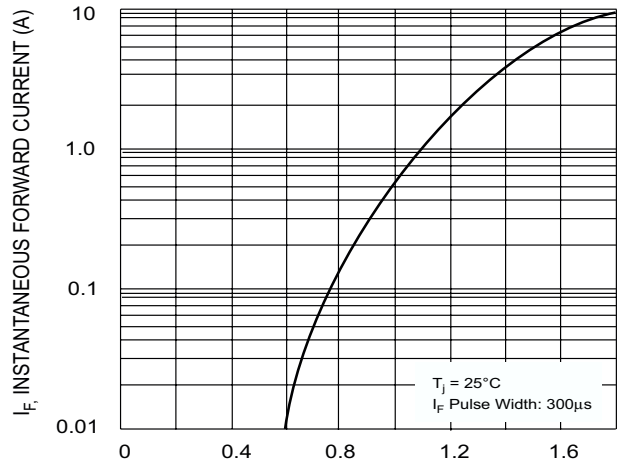

Fig. 2 Typical Forward Characteristics

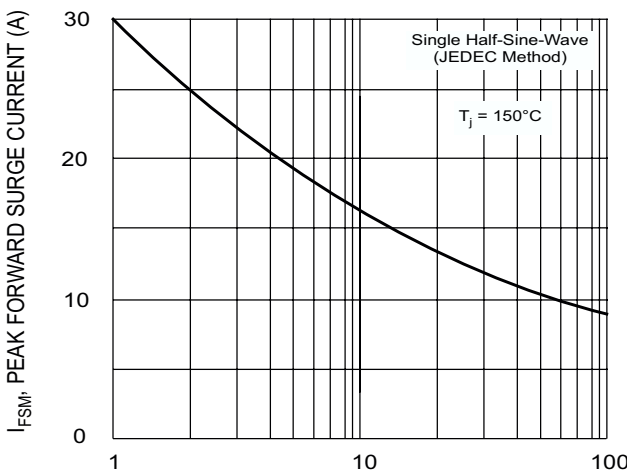

Fig. 3 Forward Surge Current Derating Curve

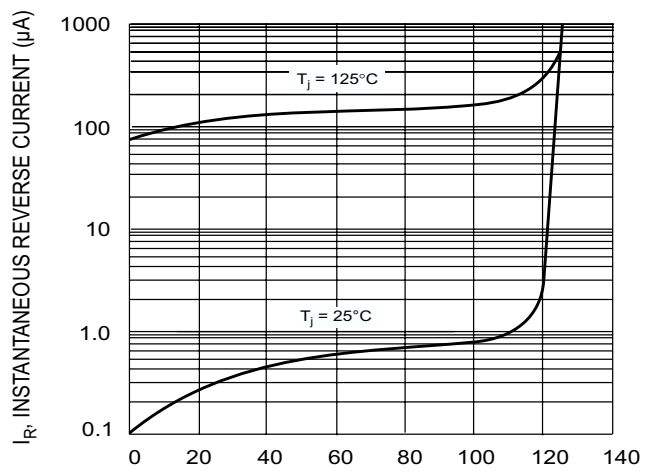
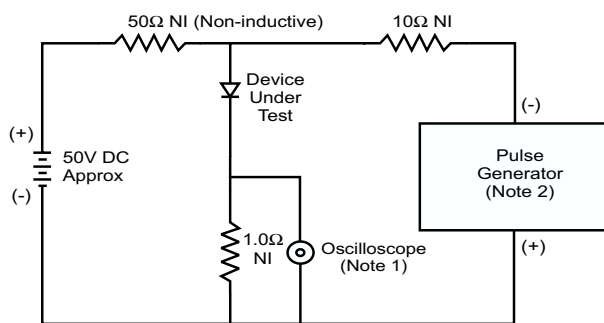
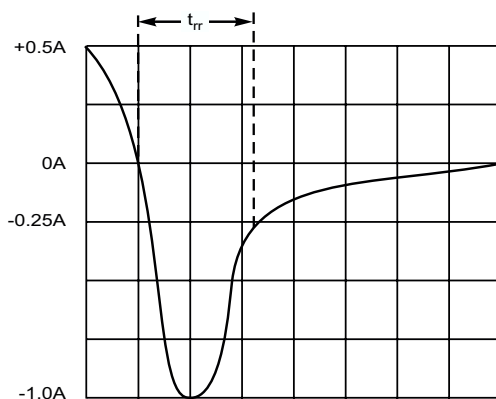

Fig. 4 Typical Reverse Characteristics



- Notes:
1. Rise Time = 7.0ns max. Input Impedance = 1.0MΩ, 22pF.
2. Rise Time = 10ns max. Input Impedance = 50Ω.



Set time base for 50/100 ns/cm

Fig. 5 Reverse Recovery Time Characteristic and Test Circuit