



FEATURES

- For surface mounted applications
- Low profile package
- Ideal for automated placement
- Glass passivated
- High temperature soldering: 260 °C/ 10 s at terminals
- Wave and reflow solderable
- AEC-Q101 qualified
- Compliant to RoHS directive 2002/95/EC and in accordance to WEEE 2002/96/EC

Mechanical Data

Case: DO-219AB (SOD-123FL)

Polarity: band denotes cathode end

Weight: approx. 15 mg

SOD-123FL

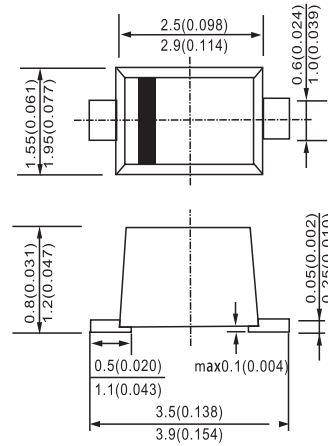

Dimensions in millimeters

MAXIMUM RATINGS AND ELECTRICAL CHARACTERISTICS

Ratings at 25 °C ambient temperature unless otherwise specified.

Single phase, half wave, 60Hz, resistive or inductive load. For capacitive load, derate current by 20%.

		RS07B	RS07D	RS07G	RS07J	RS07K	RS07M	UNITS
Device marking code		RB	RD	RG	RJ	RK	RM	
Maximum recurrent peak reverse voltage	V_{RRM}	100	200	400	600	800	1000	V
Maximum RMS voltage	V_{RMS}	70	140	280	420	560	700	V
Maximum DC blocking voltage	V_{DC}	100	200	400	600	800	1000	V
Maximum average forward rectified current $T_A=65$ (NOTE 1)	$I_{(AV)}$	0.7						A
Peak forward surge current 8.3ms single half-sine-wave superimposed on rated load $T_L=25$	I_{FSM}	20						A
Typical thermal resistance (NOTE 2)	R_{j0A}	180						K/W
Maximum reverse recovery time (NOTE 3)	t_{rr}	150			250	500		ns
Operating temperature range	T_j	- 55 --- + 150						
Storage temperature range	T_{STG}	- 55 --- + 150						

NOTES:1.Averaged over any 20 ms period.

2. Thermal resistance junction to ambient, 6.0 mm² copper pads to each terminal.

3.Measured with $I_F=0.5A$, $I_R=1A$, $I_{rr}=0.25A$.



RATINGS AND CHARACTERISTIC CURVES RS07B THRU RS07M

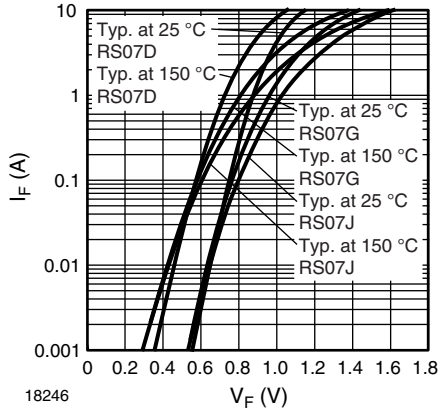

Figure 1. Typical Forward Characteristics

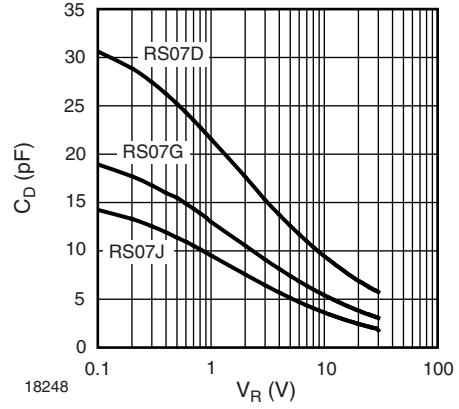

Figure 4. Typ. Diode Capacitance vs. Reverse Voltage

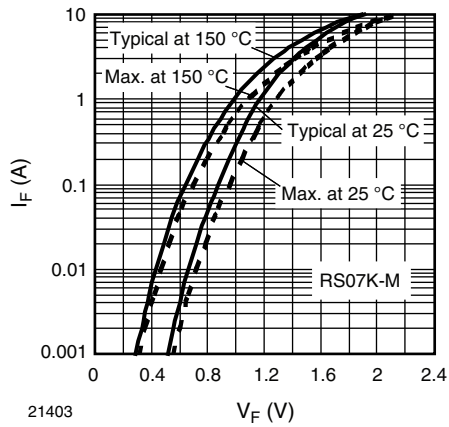

Figure 2. Typical Forward Characteristics

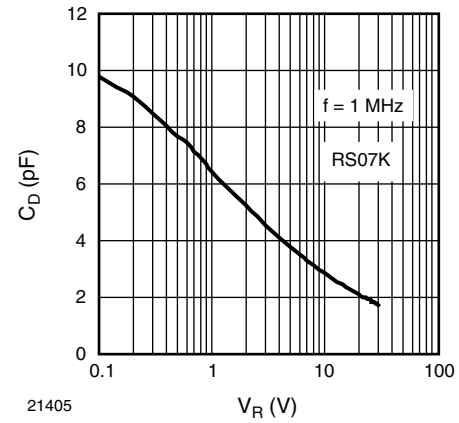

Figure 5. Typ. Diode Capacitance vs. Reverse Voltage

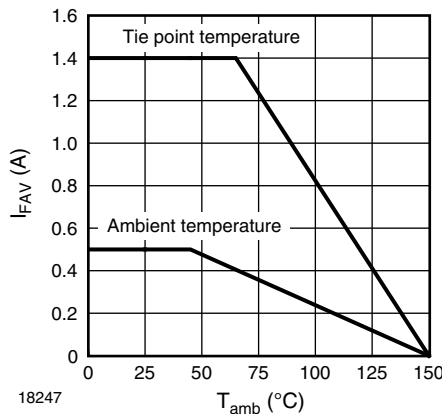

Figure 3. Forward Current Derating Curve

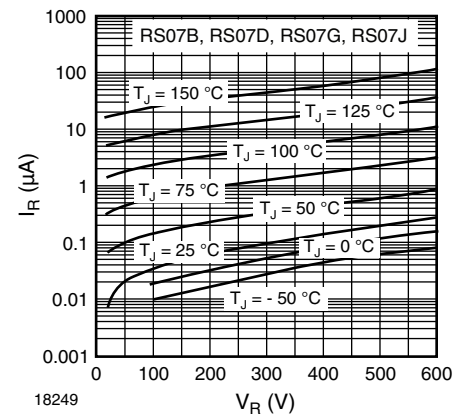

Figure 6. Typical Reverse Characteristics