



FEATURES

- Diffused Junction
- Low Forward Voltage Drop
- High Current Capability
- High Reliability
- High Surge Current Capability

MECHANICAL DATA

- Case: Molded Plastic
- Terminals: Plated Leads Solderable per MIL-STD-202, Method 208
- Polarity: Cathode Band
- Weight: 2.1 grams (approx.)
- Mounting Position: Any
- Marking: Type Number
- Epoxy: UL 94V-O rate flame retardant

R-6

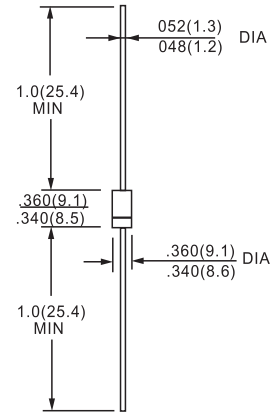

Dimensions in inches and (millimeters)

MAXIMUM RATINGS AND ELECTRICAL CHARACTERISTICS

Single Phase, half wave, 60Hz, resistive or inductive load.
For capacitive load, derate current by 20%.

Characteristic	Symbol	HER 601	HER 602	HER 603	HER 604	HER 605	HER 606	HER 607	HER 608	Unit	
Peak Repetitive Reverse Voltage	V _{RRM}									V	
Working Peak Reverse Voltage	V _{RWM}	50	100	200	300	400	600	800	1000	V	
DC Blocking Voltage	V _R									V	
RMS Reverse Voltage	V _{R(RMS)}	35	70	140	210	280	420	560	700	V	
Average Rectified Output Current (Note 1) @T _A = 55°C	I _O	6.0								A	
Non-Repetitive Peak Forward Surge Current 8.3ms Single half sine-wave superimposed on rated load (JEDEC Method)	I _{FSM}	200								A	
Forward Voltage @I _F = 6.0A	V _{FM}	1.0			1.3		1.7			V	
Peak Reverse Current At Rated DC Blocking Voltage @T _A = 25°C @T _A = 100°C	I _{RM}	10.0 100								μA	
Reverse Recovery Time (Note 2)	t _{rr}	50					75				nS
Typical Junction Capacitance (Note 3)	C _j	100					65				pF
Operating Temperature Range	T _j	-65 to +125								°C	
Storage Temperature Range	T _{STG}	-65 to +150								°C	

Note: 1. Leads maintained at ambient temperature at a distance of 9.5mm from the case
2. Measured with I_F = 0.5A, I_R = 1.0A, I_{RR} = 0.25A. See figure 5.
3. Measured at 1.0 MHz and applied reverse voltage of 4.0V D.C.



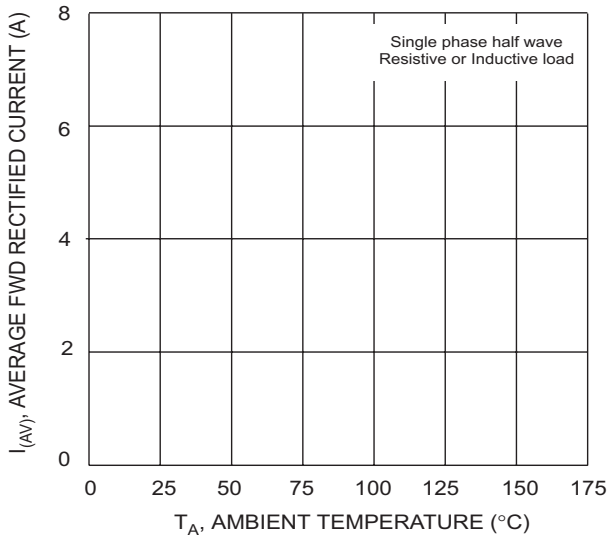

Fig. 1 Forward Current Derating Curve

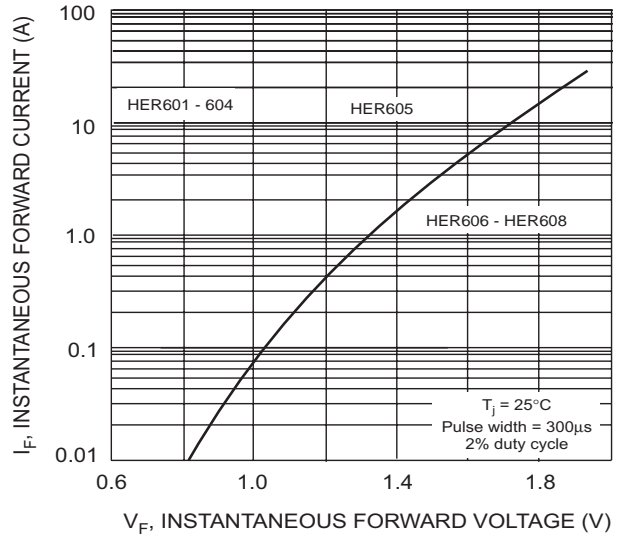

Fig. 2 Typical Forward Characteristics

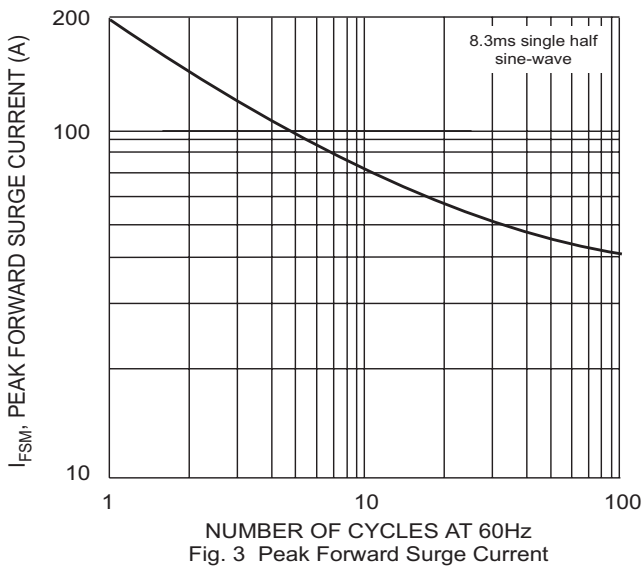

Fig. 3 Peak Forward Surge Current

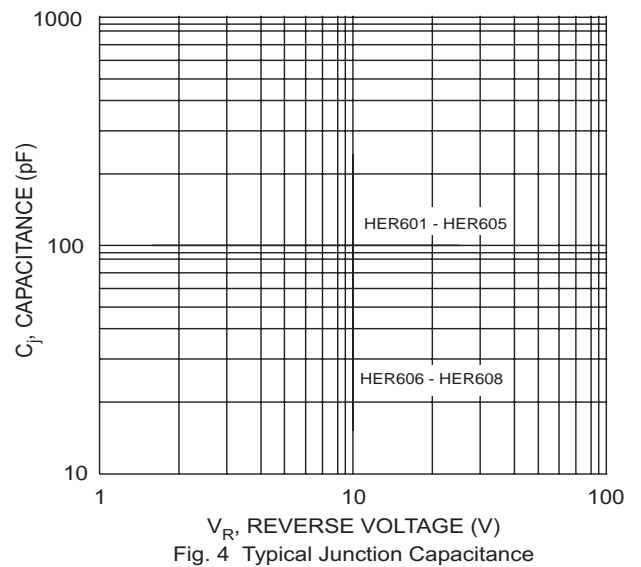
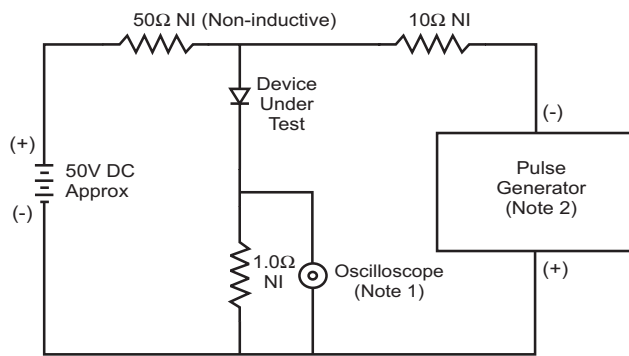

Fig. 4 Typical Junction Capacitance



- Notes:
1. Rise Time = 7.0ns max. Input Impedance = 1.0M Ω , 22pF.
2. Rise Time = 10ns max. Input Impedance = 50 Ω .

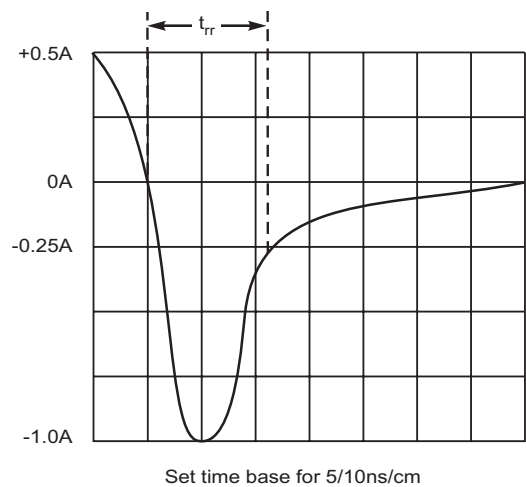

Fig. 5 Reverse Recovery Time Characteristic and Test Circuit